



INSTALLATION GUIDE

SIMBOOTH KIT 2

TABLE OF CONTENTS

Important informations	1
PC Specifications	2
Parts List	3-4
Structure assembly	5-8
Floor assembly	9-10
IDRA II installation	11
Projector installation	11-12
Cables connection	13-14
Golfn Launcher & IDRA II calibration	15
Appendix A (projector placement)	16
Appendix B (AH30ST adjustments with a monitor)	17-21
Appendix C (AH30ST adjustments without a monitor)	22-26

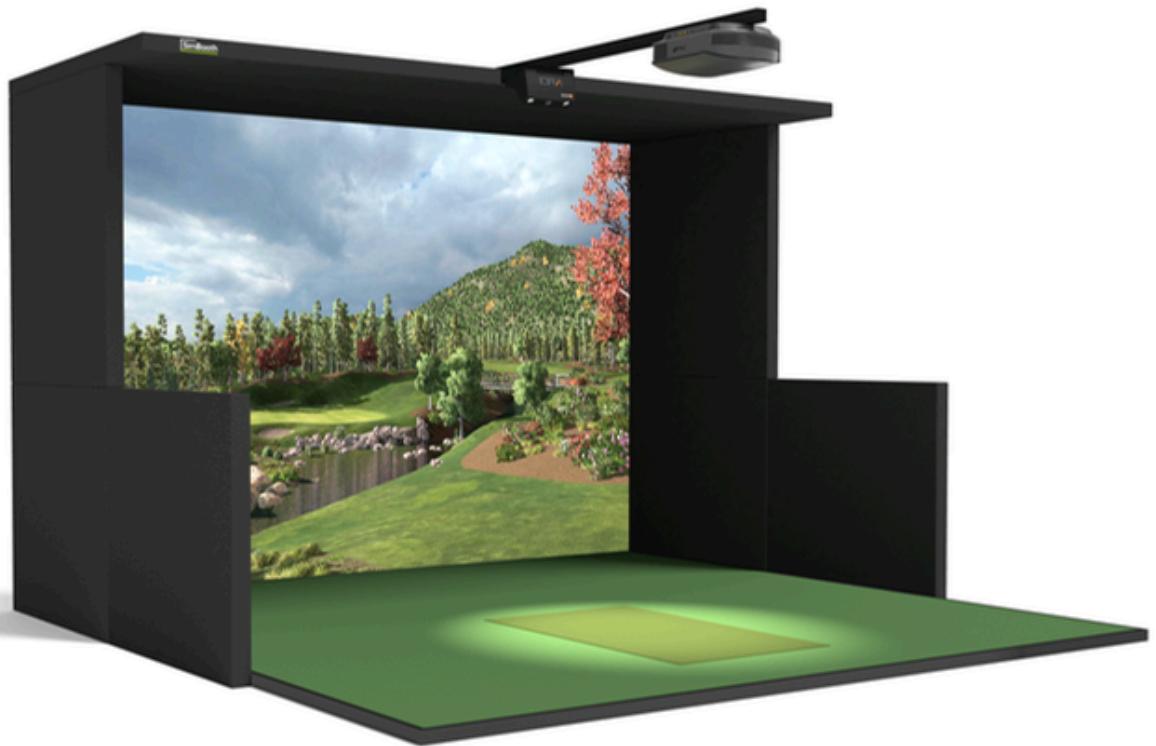

**WARNING**

PLEASE READ THE FOLLOWING BEFORE USE.

FAILURE TO FOLLOW THE INSTRUCTIONS COULD RESULT IN SERIOUS INJURY, PROPERTY DAMAGE, AND/OR VOID THE DEVICE WARRANTY.

- 1.** Do NOT install IDRA II in a location where its operating temperature may be exceeded. Excessive temperatures may damage the launch monitor. Recommended operating temperature range is 0°C – 50°C (32°F – 122°F).
- 2.** Install IDRA II in a room free of excessive dust and humidity to prevent the lens or optical components of IDRA II from becoming clouded or dirty. The recommended humidity level for the room is 30 to 65%.
- 3.** Do NOT attempt to disassemble, repair, or modify IDRA II. Doing so may result in fire, electrical shock, or injury. Contact our support team if any problems occur with the launch monitor.
- 4.** Make sure the hitting zone is not located in direct sun exposure.
- 5.** Be aware of your surroundings and use cautiously with children around.
- 6.** Do NOT install IDRA II outside. This device is only designed for indoor use.
- 7.** Do NOT touch the LED light as it may cause burns, and avoid looking directly at the light to prevent potential eye damage.

PC SPECIFICATIONS WITH GSPRO

Requirement	Minimum	Recommended
Processor	Intel Core i7, 10th Gen, with at least 16 logical processors	Intel Core i7, 10th Gen or newer, with at least 24 logical processors
Storage	512 GB	1 TB
GPU	Nvidia GeForce RTX 20 series	Nvidia GeForce RTX 40 series or newer
RAM memory	16 GB	32 GB
USB Ports	2 USB 3.0 & 1 USB-C ports are required	
Internet	High-speed Internet is required	

PC SPECIFICATIONS WITH E6 CONNECT

Requirement	Minimum	Recommended
Processor	Intel Core i7, 10th Gen or newer, with at least 16 logical processors	
Storage	512 GB	
GPU	Nvidia GeForce RTX 20 series	Nvidia GeForce RTX 30 series or newer
RAM memory	16 GB	
USB Ports	2 USB 3.0 & 1 USB-C ports are required	
Internet	High-speed Internet is required	



WARNING

AMD PROCESSORS & GPUS ARE NOT SUPPORTED.

DO NOT USE USB CABLE EXTENSION BETWEEN YOUR PC AND YOUR IDRA II.

PARTS LIST

WALL PANELS

RIGHT WALLS

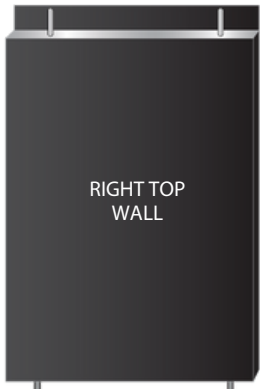

RIGHT TOP WALL

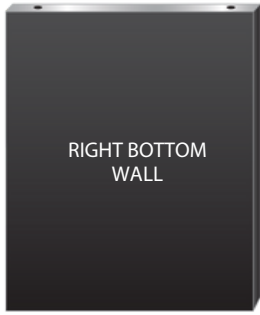

RIGHT BOTTOM WALL

LEFT WALLS



LEFT TOP WALL



LEFT BOTTOM WALL

FLOOR PANELS

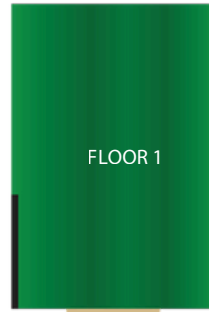

FLOOR 1



FLOOR 2



FLOOR 3



FLOOR 4



FLOOR 5

HITTING MAT



FLOOR 6

CEILING PANELS



LEFT CEILING



MIDDLE CEILING



RIGHT CEILING

PARTS LIST

ACCESSOIRES

Bolt-01 (4x)



Wing nut (5x)



Washer (32x)



Nut (28x)



Bolt-02 (4x)



Bolt-03 (8x)



Tees (10x)



Scissor bar (2x)



Hitting mat



White projection screen



Black impact screen



Shim 1/2"

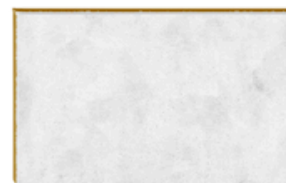

Projector beam



Shim 1/8"



Half walls (2x)

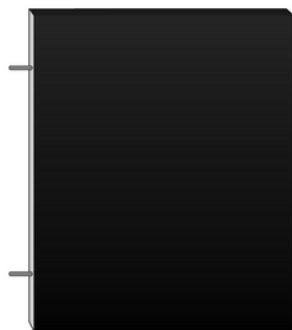

Remote & projector



Wire cover



LAUNCH MONITOR

IDRA II AI launch monitor



With power cable and two
USB camera cables (1x)

Calibration board (1x)

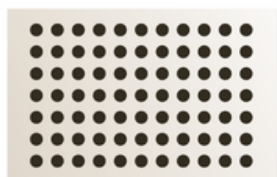

Nut + Washer
(2x)



USB Hub (1x)



Wireless remotely
operated switch (1x)
(Only included in North America)



For illustration purposes only. Model may vary.

END OF PARTS LIST

BEFORE STARTING

You will need 4 people, 2 ladders, a screwdriver and 1/2 wrench.

**1**

Attach the left top wall to the left ceiling with washers & nuts.

2x Washers
2x Nuts

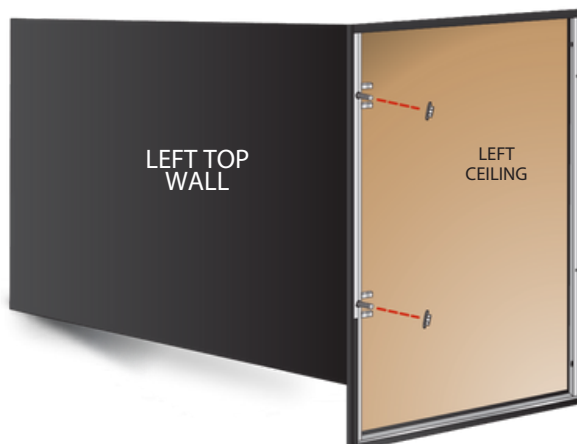
**2**

Using bolts-03, washers, and nuts, attach the middle ceiling to the left ceiling, then attach the right ceiling to the middle ceiling.

4x Washers
4x Nuts
4x Bolts-03



3

Using washers and nuts, attach the right ceiling to the right top wall.



4

Remove the bottom wall covers, then attach the bottom wall panels to the top wall panels with washers & nuts



5

(1) Unfold the scissor bars and (2) secure them with the safety pins. (3) Attach the scissor bars to both ends of the structure using wing nuts and Bolt-02. (4) Attach the scissor bars to the center of the structure using washers and Bolts-01.

4x Washers
4x Wing Nuts
4x Bolts-01
4x Bolts-02

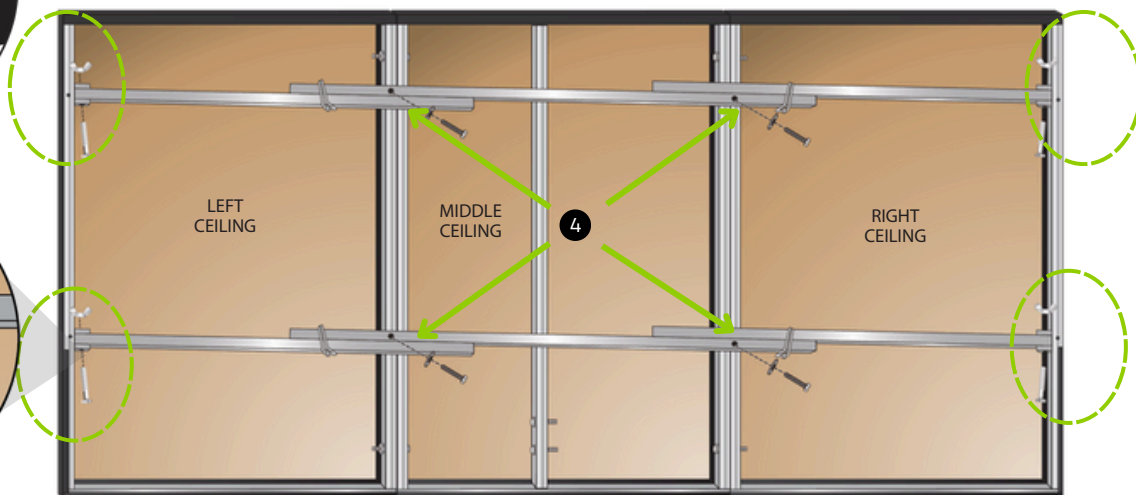
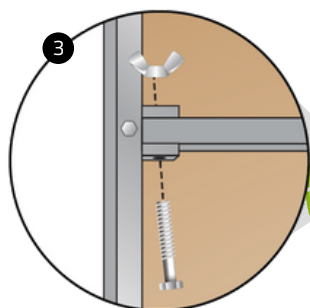
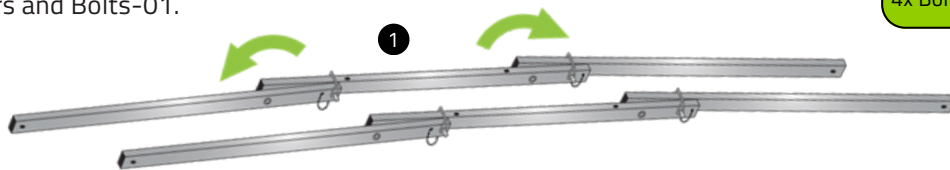
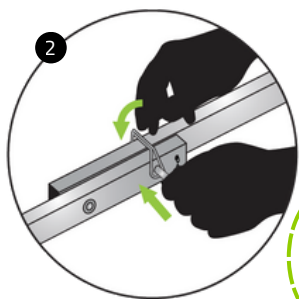

IT IS IMPORTANT TO COMPLETE THIS STEP BEFORE LIFTING THE STRUCTURE.

6

Attach the white projection screen to the structure using the velcros.

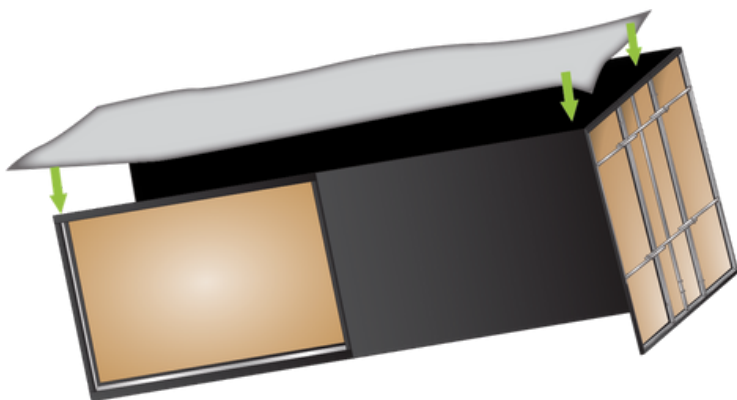

7

Attach the black impact screen over the white projection screen using the velcros. Make sure it is attached to the top velcros on the ceiling panels and that the bottom doesn't rest on the floor.

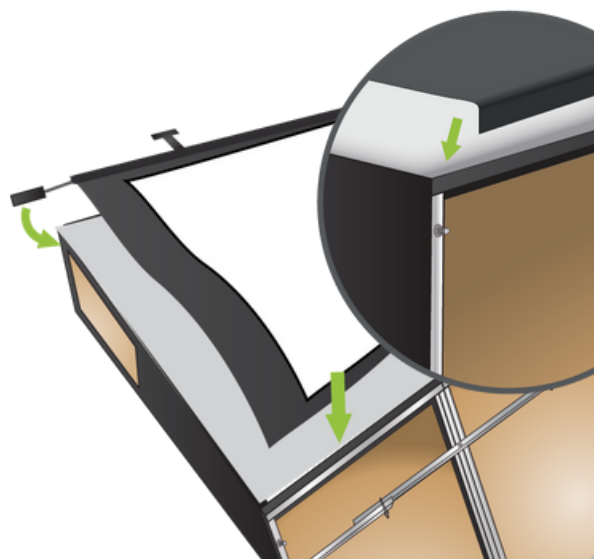

8

Lift the structure with four people.



END OF STRUCTURE INSTALLATION SECTION

1

Assemble the floor sections in order (1 to 7). For A and B, you will need bolts-03, washers, and nuts. For C, you will need washers and nuts. You can use the shim to adjust the height of the hitting mat.

6x Washers
6x Nuts
4x Bolts-03



2

Step 1

Lift green carpet.

Step 2

Stretch the white projection screen behind and under the aluminum bar and reach for it through the space.

Step 3

Fix the screen on the first half of the velcro on the aluminum bar.

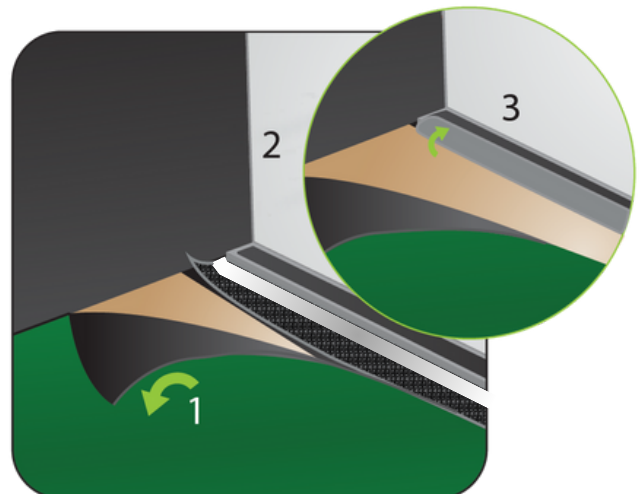

3

Step 1

Lift green carpet.

Step 2

Stretch the black impact screen behind and under the aluminum bar and reach for it through the space.

Step 3

Attach the T on the remaining half.

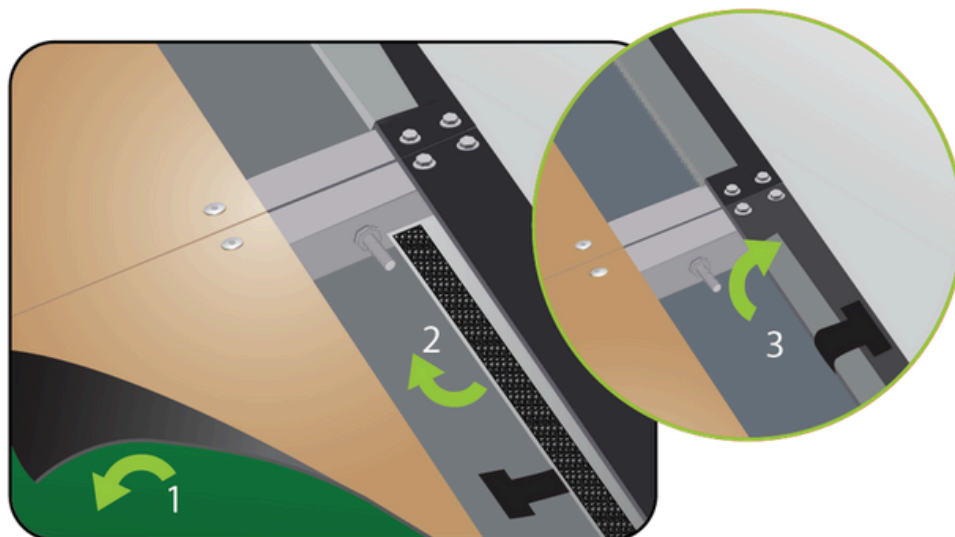

END OF STRUCTURE FLOOR INSTALLATION SECTION

HALF WALLS INSTALLATION

4x Washers
4x Nuts

Simply cut through the black carpet to access the pre-drill holes and insert the half-walls. Fix the half-walls to the structure with washers and nuts. Then, fix the removable panel on the bottom walls with the velcro.



1

IDRA II INSTALLATION

Climb on a ladder and fix the IDRA II camera through the holes that are located at the center the structure. Then, secure it tightly with two nuts on the other side.

2x Washers
2x Nuts

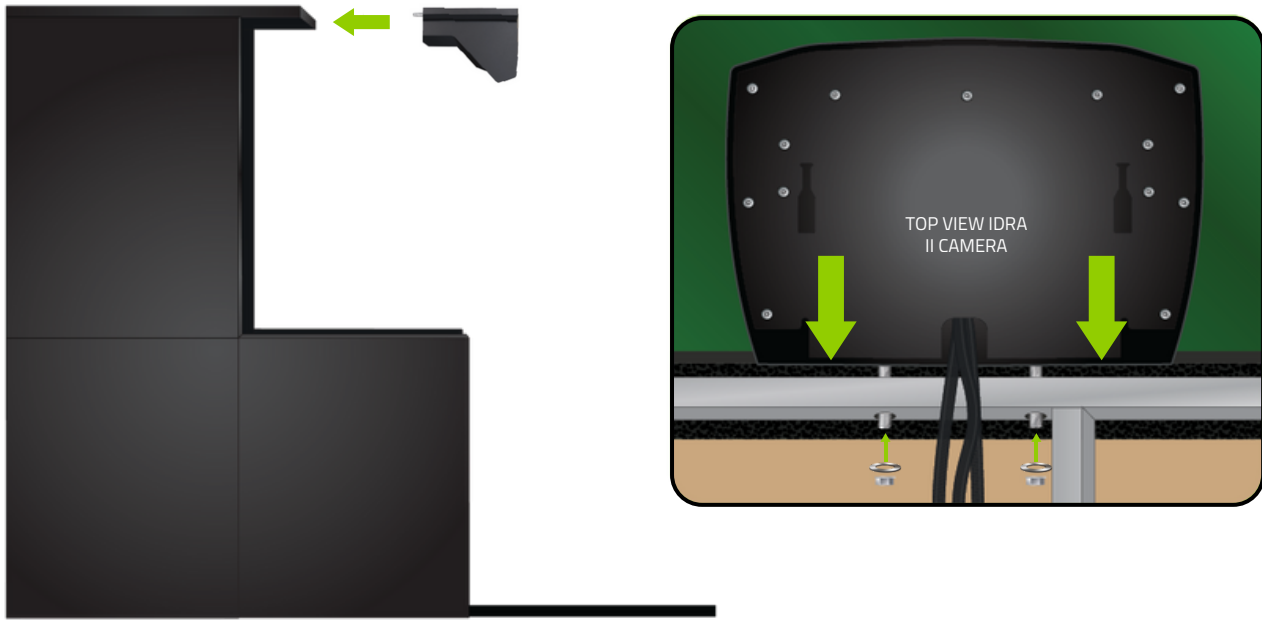

2

PROJECTOR BEAM INSTALLATION

Fix the projector beam to the ceiling structure with washers and nuts.

2x Washers
2x Nuts

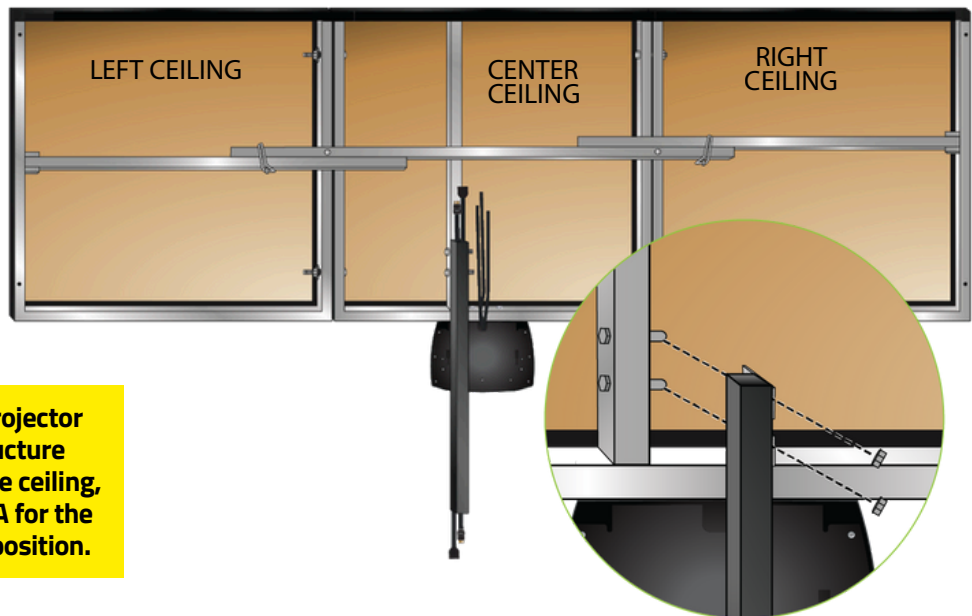

If you are not using the projector beam attached to the structure and plan to install it on the ceiling, please refer to Appendix A for the recommended projector position.

3

PROJECTOR ENCLOSURE INSTALLATION (OPTIONAL)

(A) To install the projector enclosure, first remove the rear adjuster feet of the projector completely, and slightly loosen the front adjustable foot without removing it. **(B)** Next, insert the projector into the enclosure, making sure the lens is properly aligned with the designated opening. **(C)** Finally, reinstall the removed adjustable feet through the holes of the enclosure to secure the projector in place, and re-tighten the front adjustable foot.

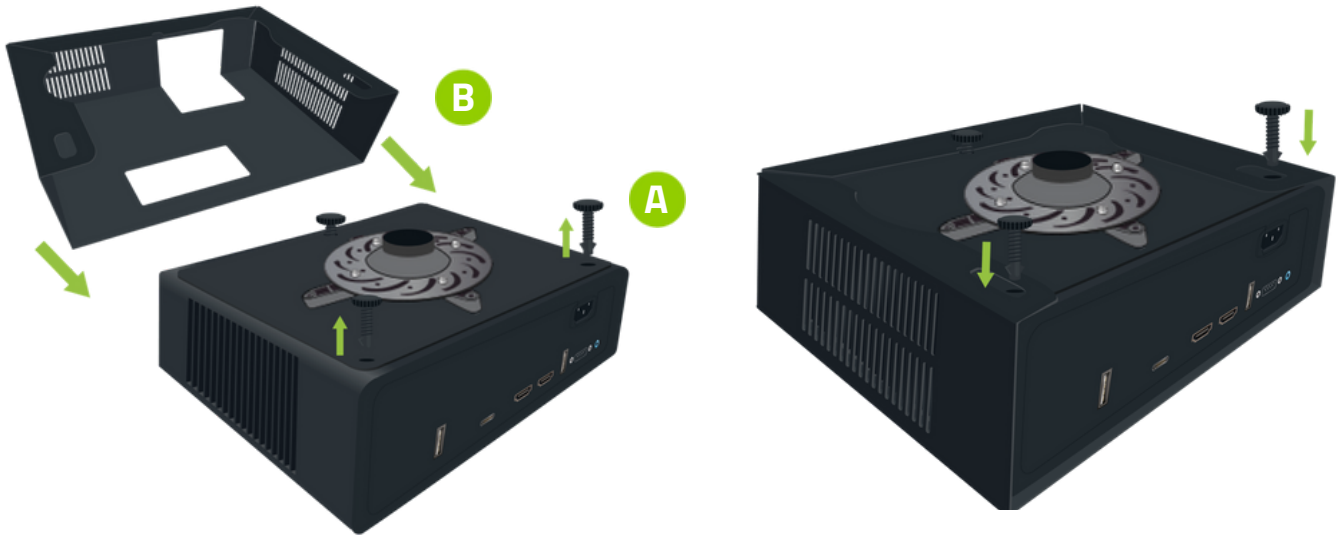

4

PROJECTOR INSTALLATION

Attach the projector on the projector mount. Refer to the instruction sheet inside the projector box.



5

IDRA CABLE CONNECTIONS

Connect the power cable (country-specific) to the wireless remote switch. Then, plug the wireless remote switch into your electrical outlet. Connect one of the two USB camera cables to the USB 3.0 SS port on your PC and the other to the hub. Plug the hub into the USB-C port on your PC. Make sure the USB cables are not under tension.



6

PROJECTOR CABLE CONNECTIONS

Plug the HDMI cable to the HDMI port on your projector and on your PC. Connect the power cable to the ground terminal and your electrical outlet. **Refer to Appendix B, C, D or E for your projector adjustments.**

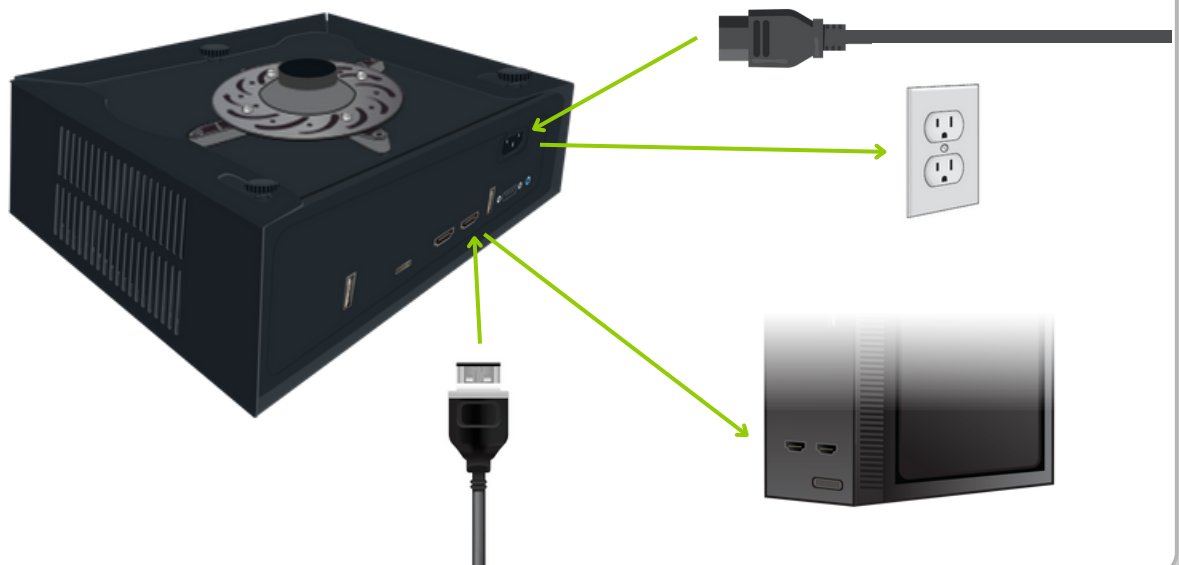

WIRE COVER

Stick one side of the wire cover to the structure using the Velcro. Gather your wires inside the wire cover and, forming a loop over the wires, stick the second side of the wire cover just in front of your first Velcro.

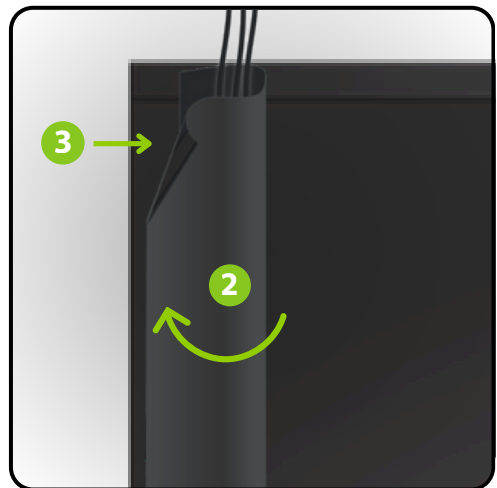
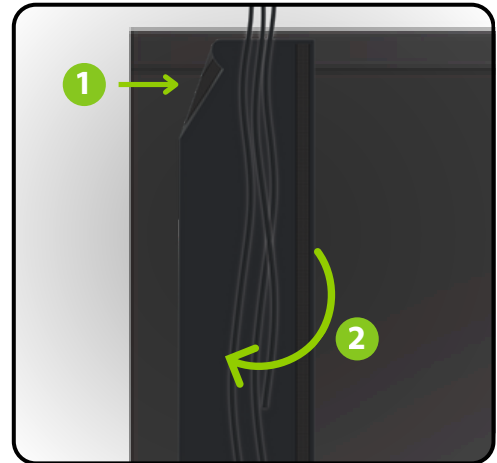

GOLFIN LAUNCHER INSTALLATION AND IDRA II CALIBRATION

Follow these steps to complete your installation:

STEP 1

Ensure your computer is connected to the Internet.

STEP 2

Confirm that you have purchased the necessary software. IDRA II is compatible with GSPro and E6 Connect.

STEP 3

Visit <https://simbooth.com/steps-to-follow/>, then start following the steps from Step 2.

PROJECTOR PLACEMENT WHEN NOT USING THE PROJECTOR BEAM

- Minimum projector distance:
150" (screen to lens)
- Maximum projector distance:
163" (screen to lens)
- Projector Height:
88" (floor to the middle of the lens)

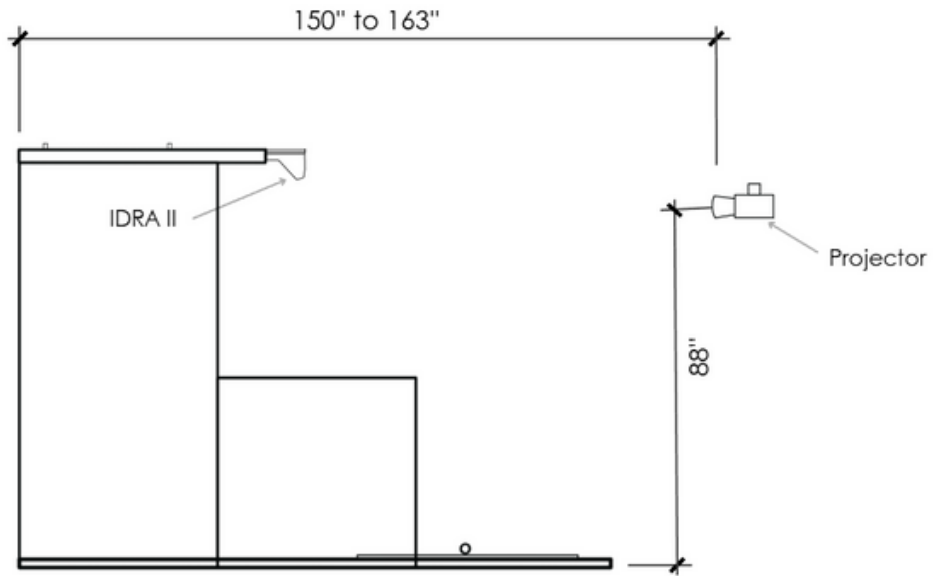

FULL-SCREEN PROJECTION ONLY AVAILABLE WITH THE AK700ST

BENQ AH30ST PROJECTOR AJUSTEMENTS WITH MONITOR

TABLE OF CONTENTS

- | | |
|-----------------------------------|--------------------------|
| 1. Select the correct HDMI Source | 4. Projector Settings |
| 2. NVIDIA Control Panel (PC) | 5. Projector Ajustements |
| 3. Windows Display Settings (PC) | |

1. SELECT THE CORRECT HDMI SOURCE

1. Turn on the projector and press the 'Source' button on the remote control.
2. Use the arrows to navigate to the appropriate HDMI input (HDMI 1 or HDMI 2) and press 'OK' to select.

2. WINDOWS DISPLAY SETTINGS (PC)

1. Open the NVIDIA Control Panel & make sure the projector is turned on.
2. Click on "Adjust desktop size and position"
3. Select your monitor
4. Select "Aspect ratio"
5. Keep the resolution at 1920 x 1080
6. Select your projector
7. Select "Aspect ratio"
8. Keep the resolution at 1920 x 1080
9. Click "Apply" at the bottom right of the screen. Then "Yes" to "Apply Changes"

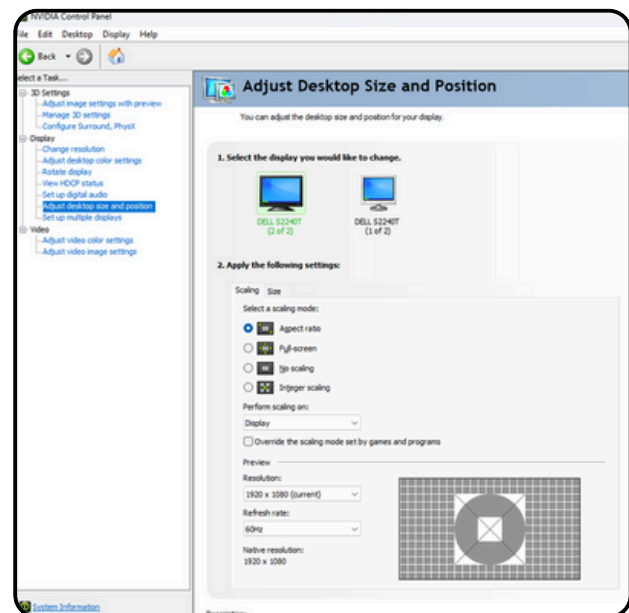

3. WINDOWS DISPLAY SETTINGS (PC)

1. Click Start > Settings
2. Go to System > Display
3. If both screens are detected, you will see two numbered rectangles (1 and 2)
4. Click on Extend these Display (menu below and to the right of the 2 screens)
5. Select "Duplicate these displays"
6. Click "Keep Change"
7. Make sure the display resolution is set to 1920 x 1080

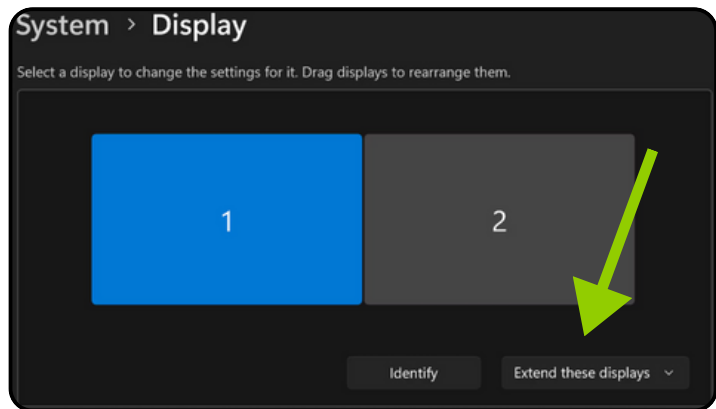

4. PROJECTOR SETTINGS

1. Language: Select the desired language
2. Menu (On the remote) : Menu Type > Choose Advanced
3. Picture > Picture Mode: Select Golf



4. PROJECTOR SETTINGS (CONTINUED)

4. Display > Screen Fill: Choose 16:9 (1920 x 1080)

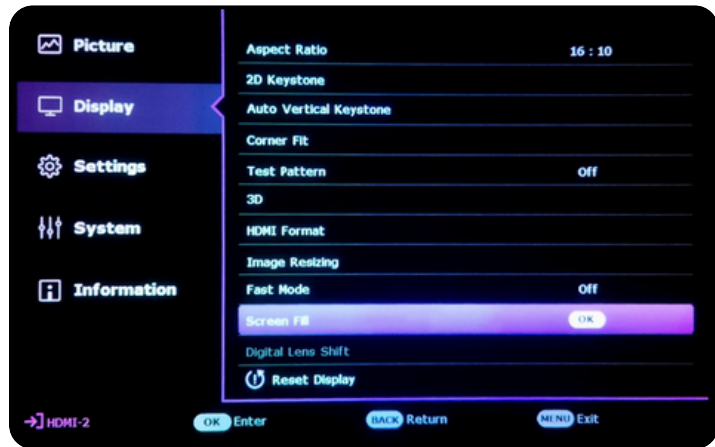

5. Display > Aspect Ratio : Select 16:10

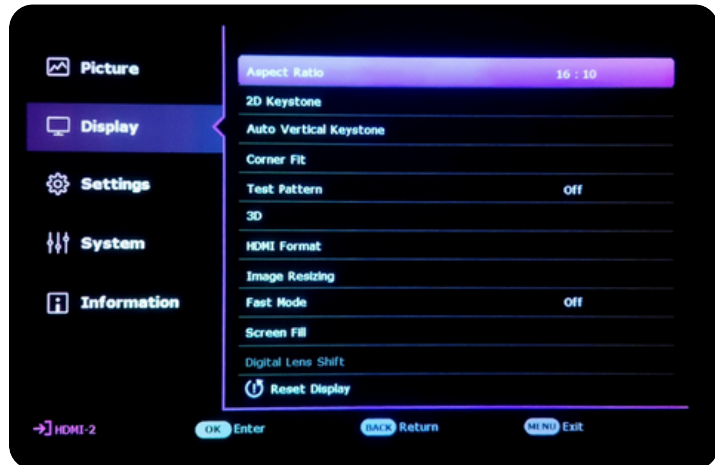

5. PROJECTOR AJUSTEMENTS

Each environment is unique, so this section may require a bit more time and patience. Depending on your setup (screen size, projector distance, ceiling height, etc.), the adjustments needed can vary significantly from one user to another.

Take the time to explore and combine the different adjustments below to achieve an image perfectly suited to your installation. Don't hesitate to repeat the process multiple times to fine-tune the result to your preferences.

- Zoom: Adjust the image size using the zoom dial under the lens



- Display > Image Resizing: Use Digital Shrink & Shift → Adjust the image so that it slightly exceeds the desired size on all sides

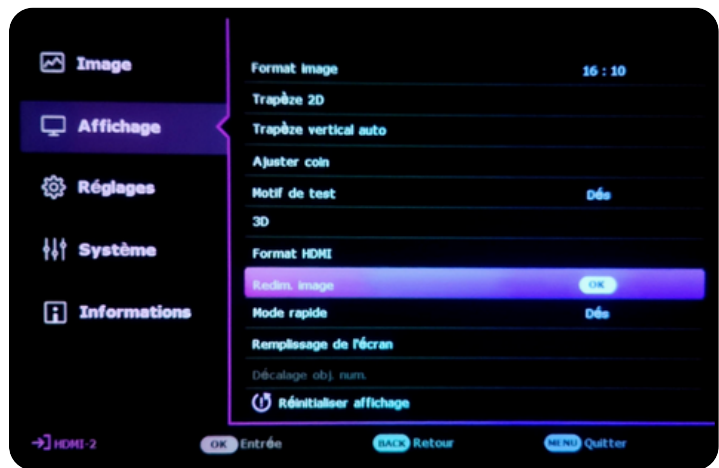

5. PROJECTOR AJUSTEMENTS (CONTINUED)

- Display > 2D Keystone: Correct vertical tilt and horizontal shift of the image



- Display > Corner Fit: Fine-tune the image size and position for precise alignment



- Focus: Adjust image sharpness using the focus dial under the lens



BENQ AH30ST PROJECTOR AJUSTEMENTS WITHOUT MONITOR

TABLE OF CONTENTS

- | | |
|-----------------------------------|--------------------------|
| 1. Select the correct HDMI Source | 4. Projector Settings |
| 2. NVIDIA Control Panel (PC) | 5. Projector Ajustements |
| 3. Windows Display Settings (PC) | |

1. SELECT THE CORRECT HDMI SOURCE

1. Turn on the projector and press the 'Source' button on the remote control.
2. Use the arrows to navigate to the appropriate HDMI input (HDMI 1 or HDMI 2) and press 'OK' to select.

2. WINDOWS DISPLAY SETTINGS (PC)

1. Open the NVIDIA Control Panel
2. Click on Change resolution:
 - Customise > Create custom resolution
3. Under Display mode (as reported by Windows), Change :
 - Horizontal pixels to 1547
 - Vertical Lines to 1080
4. Click on Test > Apply change > Yes
5. Click on Adjust desktop size and position:
6. Select "Aspect ratio" (The projector must be turned on beforehand)
7. Change the Resolution to 1547 × 1080
8. Click "Apply" at the bottom right of the screen. Then "Yes" to "Apply Changes"

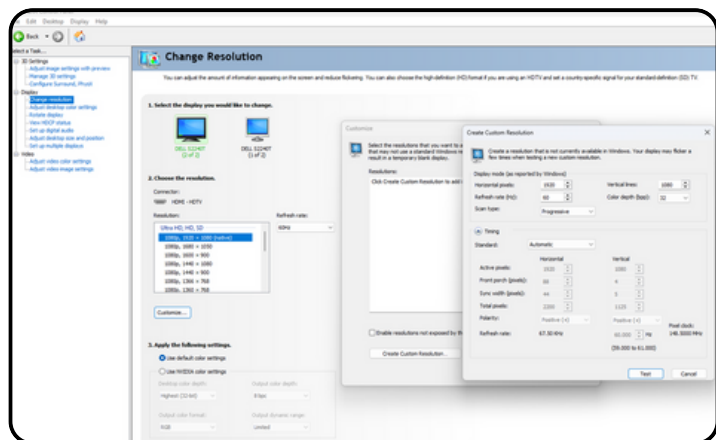

3. WINDOWS DISPLAY SETTINGS (PC)

1. Click Start > Settings
2. Go to System > Display
3. Make sure the display resolution is set to 1547 × 1080
4. If not, change it & Click "Yes" to Keep these display setting

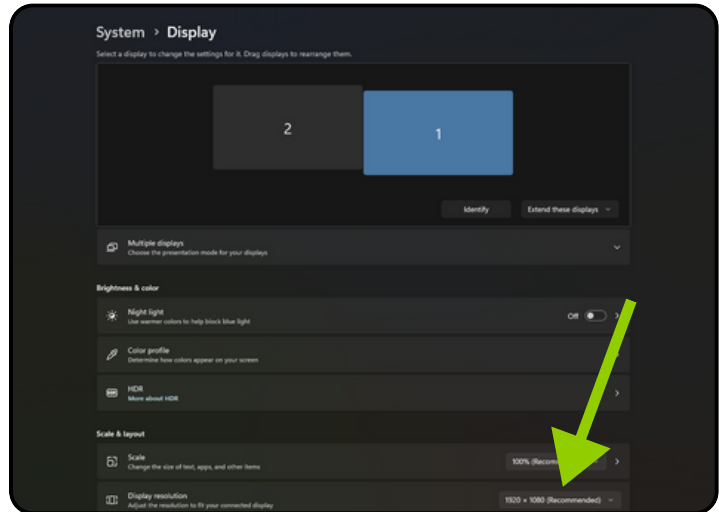

4. PROJECTOR SETTINGS

1. Language: Select the desired language
2. Menu (On the remote) : Menu Type > Choose Advanced
3. Picture > Picture Mode: Select Golf



4. PROJECTOR SETTINGS (CONTINUED)

4. Display > Screen Fill: Choose 16:9 (1920 x 1080)



5. Display > Aspect Ratio : Select 16:10

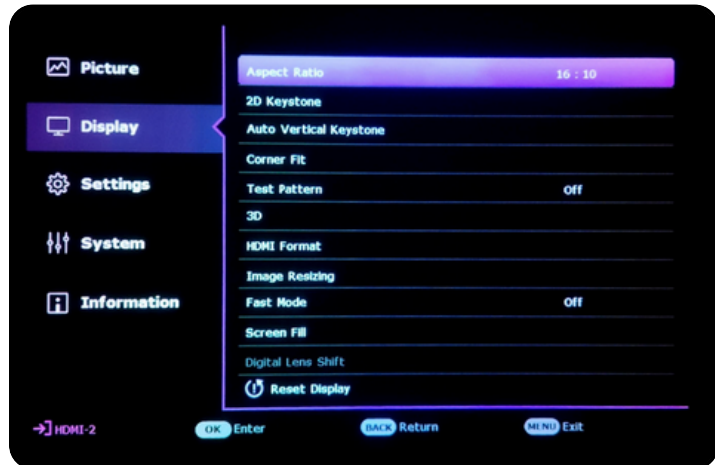

5. PROJECTOR AJUSTEMENTS

Each environment is unique, so this section may require a bit more time and patience. Depending on your setup (screen size, projector distance, ceiling height, etc.), the adjustments needed can vary significantly from one user to another.

Take the time to explore and combine the different adjustments below to achieve an image perfectly suited to your installation. Don't hesitate to repeat the process multiple times to fine-tune the result to your preferences.

- Zoom: Adjust the image size using the zoom dial under the lens



- Display > Image Resizing: Use Digital Shrink & Shift → Adjust the image so that it slightly exceeds the desired size on all sides



5. PROJECTOR AJUSTEMENTS (CONTINUED)

- Display > 2D Keystone: Correct vertical tilt and horizontal shift of the image



- Display > Corner Fit: Fine-tune the image size and position for precise alignment



- Focus: Adjust image sharpness using the focus dial under the lens

